

ICPLW50L

DESCRIPTION

The ICPLW50L 1MBd digital optocoupler consists of a high efficient AlGaAs Light Emitting Diode and a high speed optical detector. The output of the optical detector features an open collector Schottky clamped transistor. The internal shield ensures high common mode transient immunity.

The device is in Stretched SO6 package.

FEATURES

- High speed – 1MBd typical
- Stretched SO6 Package
- Wide Operating Voltage Range
V_{CC} 2.7V to 24V
- Low Drive Current 3mA
- Package Clearance / Creepage 8mm
- 15kV/μs Minimum Common Mode Rejection at V_{CM} = 1500V
- Guarantee Performance over Temperature Range: -40°C to 105°C
- TTL Compatible
- Open collector output
- Lead Free and RoHS Compliant
- UL File E91231 Model “W501”

APPLICATIONS

- Digital Signal Isolation
- Communications Interface
- Micro-controller Interface
- Digital Isolation for A/D, D/A Conversion
- Switching Power Supplies

ORDER INFORMATION

- Supplied in Tape and Reel

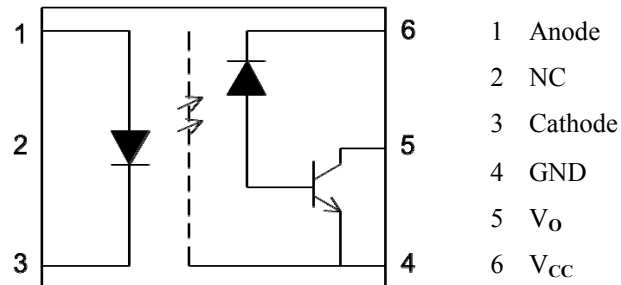

A 0.1μF bypass Capacitor must be connected between Pins 6 and 4.

ABSOLUTE MAXIMUM RATINGS

T_A = 25°C unless otherwise specified.

Stresses exceeding the absolute maximum ratings can cause permanent damage to the device.

Exposure to absolute maximum ratings for long periods of time can adversely affect reliability.

Input

Forward Current	20mA
Forward Peak Current (Pulse Width = 1ms, 50% Duty Cycle)	40mA
Forward Peak Transient Current (Pulse Width = 1μs, 300pps)	1.0A
Reverse Voltage	5V
Power dissipation	36mW

Output

Output Collector Current	8mA
Peak Output Current	16mA
Supply Voltage	-0.5 to 30V
Output Collector Voltage	-0.5 to 20V
Power Dissipation	100mW

Total Package

Isolation Voltage	5000V _{RMS}
Operating Temperature	-40 to 105 °C
Storage Temperature	-55 to 125 °C
Lead Soldering Temperature (10s)	260°C

ISOCOM COMPONENTS 2004 LTD

Unit 25B, Park View Road West, Park View Industrial Estate
Hartlepool, Cleveland, TS25 1UD, United Kingdom
Tel: +44 (0)1429 863 609 Fax: +44 (0)1429 863 581
e-mail: sales@isocom.co.uk
<http://www.isocom.com>

ISOCOM COMPONENTS ASIA LTD

Hong Kong Office,
Block A, 8/F, Wah Hing Industrial Mansions,
36 Tai Yau Street, San Po Kong, Kowloon, Hong Kong.
Tel: +852 2995 9217 Fax: +852 8161 6292
e-mail sales@isocom.com.hk

ICPLW50L

Truth Table

LED	V _o
OFF	HIGH
ON	LOW

Recommended Operating Conditions

Parameter	Symbol	Min	Max	Unit
Operating Temperature	T _A	- 40	105	°C
Supply Voltage	V _{CC}	2.7	24	V
Input Current (ON)	I _{FH}	3	10	mA
Input Voltage (OFF)	V _{F(OFF)}		0.8	V



ICPLW50L

ELECTRICAL CHARACTERISTICS ($V_{CC} = 2.7$ to $24V$, $I_F = 3mA$ and $T_A = -40^{\circ}C$ to $105^{\circ}C$, unless otherwise specified)

INPUT

Parameter	Symbol	Test Condition	Min	Typ.	Max	Unit
Forward Voltage	V_F	$I_F = 3mA$	1.2	1.4	1.8	V
Reverse Voltage	V_R	$I_R = 10\mu A$	5			V

OUTPUT

Parameter	Symbol	Test Condition	Min	Typ.	Max	Unit
High Level Supply Current	I_{CCH}	$I_F = 0mA$, $V_{CC} = 30V$, $V_O = \text{Open}$, $T_A = 25^{\circ}C$			2	μA
Low Level Supply Current	I_{CCL}	$I_F = 3mA$, $V_{CC} = 30V$ $V_O = \text{Open}$		60	100	μA
High Level Output Current	I_{OH}	$I_F = 0mA$, $V_O = V_{CC} = 5.5V$, $T_A = 25^{\circ}C$			0.5	μA
		$I_F = 0mA$, $V_{CC} = 30V$, $V_O = 20V$, $T_A = 25^{\circ}C$			1	
		$I_F = 0mA$, $V_{CC} = 30V$, $V_O = 20V$			80	
Low Level Output Voltage	V_{OL}	$I_F = 3mA$, $V_{CC} = 3.3V$ or $5V$, $I_O = 3mA$, $T_A = 25^{\circ}C$		0.25	0.4	V
		$I_F = 3mA$, $V_{CC} = 3.3V$ or $5V$, $I_O = 1.6mA$, $T_A = 25^{\circ}C$		0.25	0.5	

COUPLED

Parameter	Symbol	Test Condition	Min	Typ.	Max	Unit
Current Transfer Ratio	CTR	$I_F = 3mA$, $V_{CC} = 3.3V$ or $5V$, $V_O = 0.4V$, $T_A = 25^{\circ}C$	90	125	200	%
		$I_F = 3mA$, $V_{CC} = 3.3V$ or $5V$, $V_O = 0.5V$,	53			



ICPLW50L

ELECTRICAL CHARACTERISTICS ($V_{CC} = 2.7$ to $24V$, $I_F = 3mA$ and $T_A = -40^{\circ}C$ to $105^{\circ}C$, unless otherwise specified)

SWITCHING

Parameter	Symbol	Test Condition	Min	Typ.	Max	Unit
Propagation Delay Time to High Output Level	t_{PLH}	$f = 10kHz$, Duty Cycle = 50%, $I_F = 3mA$, $V_{CC} = 3.3V$, $R_L = 1.8K\Omega$, $C_L = 15pF$, $V_{THLH} = 2V$		0.4	1.4	μs
		$f = 10kHz$, Duty Cycle = 50%, $I_F = 3mA$, $V_{CC} = 5.0V$, $R_L = 2.9K\Omega$, $C_L = 15pF$, $V_{THLH} = 2V$		0.4	1	
Propagation Delay Time to Low Output Level	t_{PHL}	$f = 10kHz$, Duty Cycle = 50%, $I_F = 3mA$, $V_{CC} = 3.3V$, $R_L = 1.8K\Omega$, $C_L = 15pF$, $V_{THHL} = 1.5V$		0.3	1	
		$f = 10kHz$, Duty Cycle = 50%, $I_F = 3mA$, $V_{CC} = 5.0V$, $R_L = 2.9K\Omega$, $C_L = 15pF$, $V_{THHL} = 1.5V$		0.3	1	
Pulse Width Distortion $ t_{PHL} - t_{PLH} $ for any given device	PWD	$f = 10kHz$, Duty Cycle = 50%, $I_F = 3mA$, $V_{CC} = 3.3V$, $R_L = 1.8K\Omega$, $C_L = 15pF$, $V_{THLH} = 2V$ $V_{THHL} = 1.5V$		0.1	1.4	
		$f = 10kHz$, Duty Cycle = 50%, $I_F = 3mA$, $V_{CC} = 5.0V$, $R_L = 2.9K\Omega$, $C_L = 15pF$, $V_{THLH} = 2V$ $V_{THHL} = 1.5V$		0.1	1	
Common Mode Transient Immunity at High Output Level	CM_H	$I_F = 0mA$, $V_{CC} = 3.3V$ or $5V$, $V_{CM} = 1500V$ p-p $R_L = 1.8K\Omega$ or $2.9k\Omega$, $T_A = 25^{\circ}C$	15			$kV/\mu s$
Common Mode Transient Immunity at Low Output Level	CM_L	$I_F = 3mA$, $V_{CC} = 3.3V$ or $5V$, $V_{CM} = 1500V$ p-p, $R_L = 1.8K\Omega$ or $2.9k\Omega$, $T_A = 25^{\circ}C$	15			$kV/\mu s$



ICPLW50L

ELECTRICAL CHARACTERISTICS ($V_{CC} = 2.7$ to $24V$, $I_F = 3mA$ and $T_A = -40^{\circ}C$ to $105^{\circ}C$, unless otherwise specified)

ISOLATION

Parameter	Symbol	Test Condition	Min	Typ.	Max	Unit
Insulation Voltage	V_{ISO}	$t = 1 \text{ min,}$ $T_A = 25^{\circ}C, RH \leq 50\%$	5000			V
Input - Output Resistance	R_{I-O}	$V_{I-O} = 500VDC$		10^{12}		Ω
Input - Output Insulation Leakage Current	I_{I-O}	$V_{I-O} = 3kVDC, t = 5s,$ $T_A = 25^{\circ}C, RH 45\%$			1.0	μA

Note :

1. A 0.1 μF bypass capacitor must be connected across pin 6 and pin 4.
2. CM_H , Common Mode Transient Immunity in High stage is the maximum tolerable positive dV_{CM}/dt on the leading edge of the common mode impulse signal, V_{CM} , to assure that the output will remain high ($V_O > 2.0V$).
3. CM_L , Common Mode Transient Immunity in Low stage is the maximum tolerable negative dV_{CM}/dt on the trailing edge of the common mode impulse signal, V_{CM} , to assure that the output will remain low ($V_O < 0.8V$).

ICPLW50L

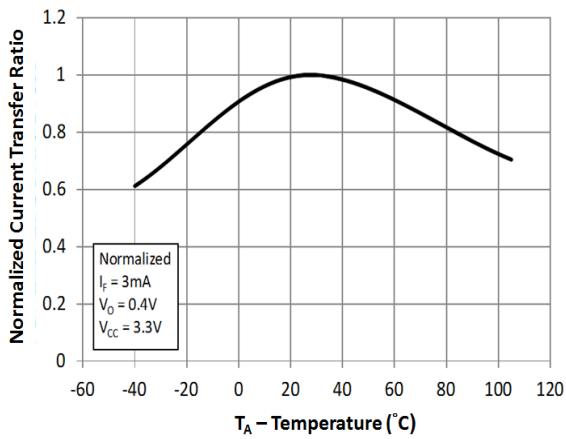

Fig 1 Normalized Current Transfer Ratio vs Ambient Temperature (V_{cc}=3.3V)

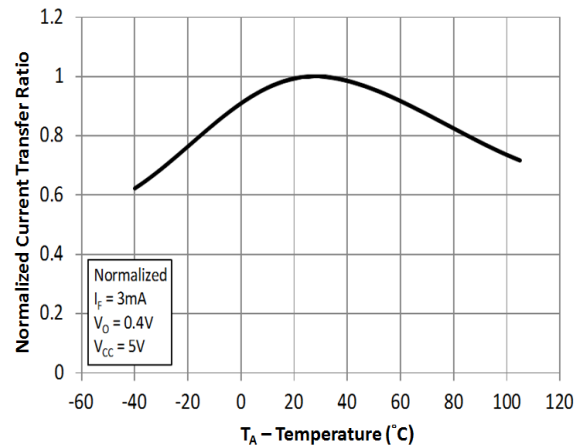

Fig 2 Normalized Current Transfer Ratio vs Ambient Temperature (V_{cc}=5V)

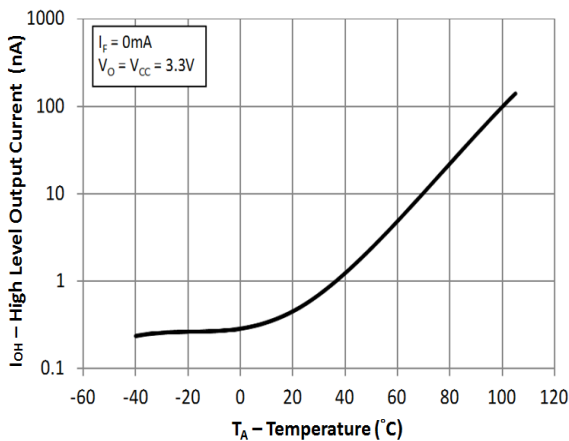

Fig 3 Typical High Level Output Current vs Ambient Temperature (V_o=V_{cc}=3.3V)

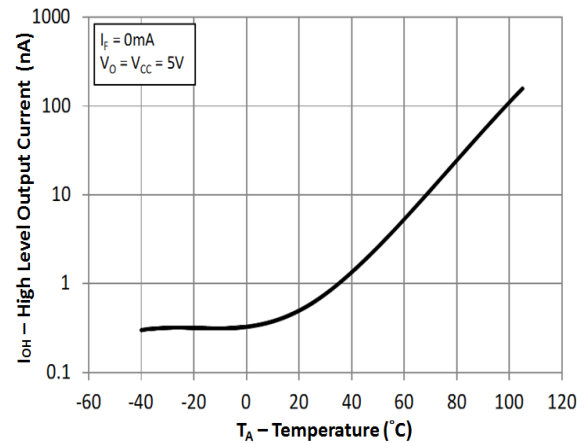

Fig 4 Typical High Level Output Current vs Ambient temperature (V_o=V_{cc}=5V)

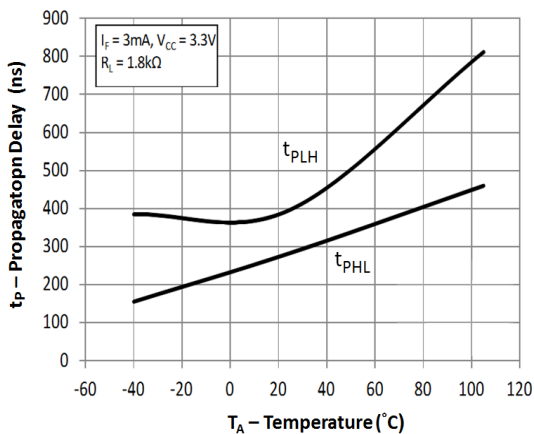

Fig 5 Typical Propagation Delay vs Ambient Temperature (V_{cc}=3.3V R_L=1.8kΩ)

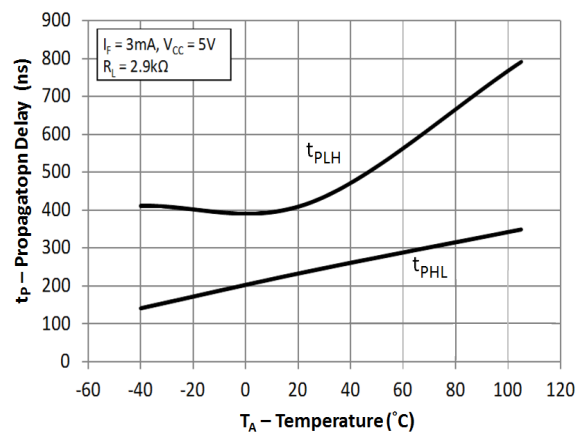

Fig 6 Typical Propagation Delay vs Ambient Temperature (V_{cc}=5V R_L=2.9kΩ)

ICPLW50L

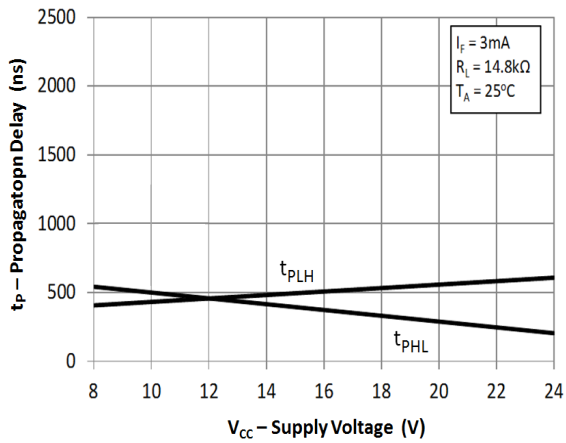

Fig 7 Typical Propagation Delay vs Supply Voltage

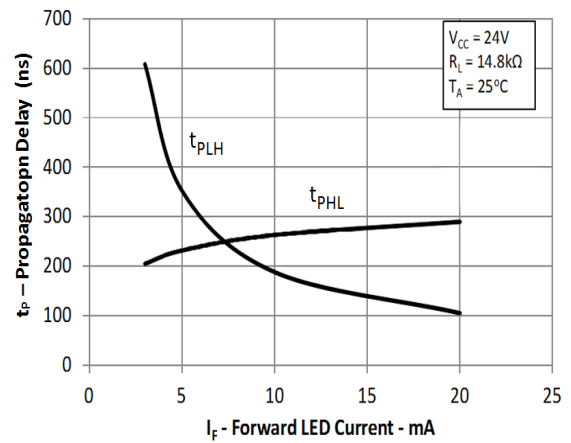

Fig 8 Typical Propagation Delay vs Forward Current

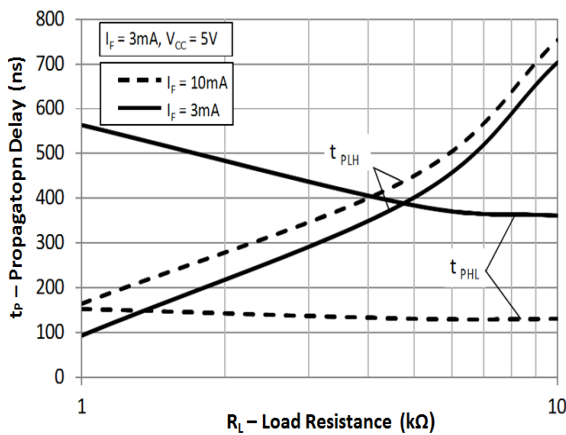

Fig 9 Typical Propagation Delay vs Load Resistance

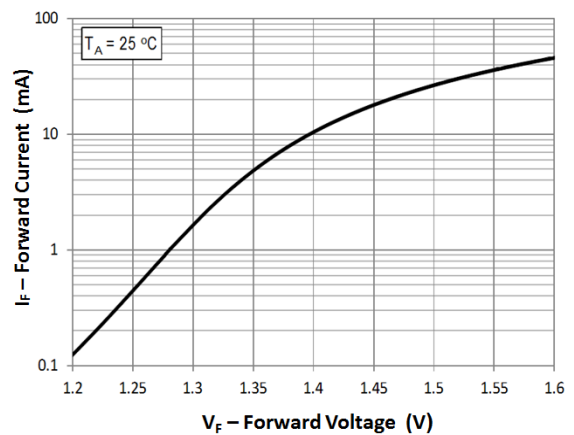
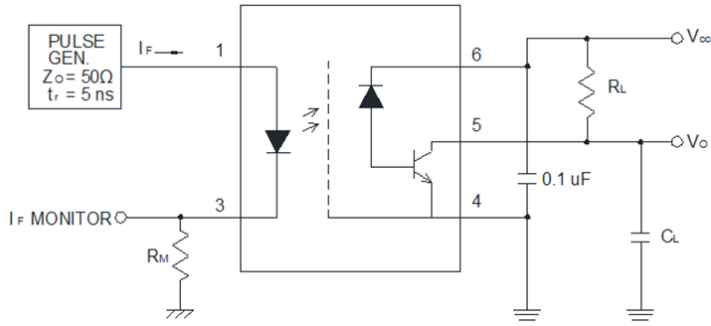
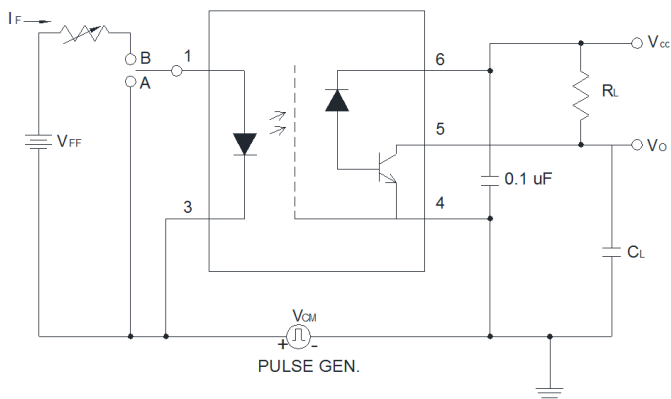

Fig 10 Forward Current vs Forward Voltage

ICPLW50L



Switching Test Circuit and Waveforms



CMR Test Circuit and Waveforms

ICPLW50L

ORDER INFORMATION

ICPLW50L			
After PN	PN	Description	Packing quantity
None	ICPLW50L	Stretched SO6	1000 pcs per reel

DEVICE MARKING



W501	denotes Device Part Number
L	
/	denotes Isocom
YY	denotes 2 digit Year code
WW	denotes 2 digit Week code

ICPLW50L

PACKAGE DIMENSIONS and Recommended PCB Pad Layout in mm (inch)

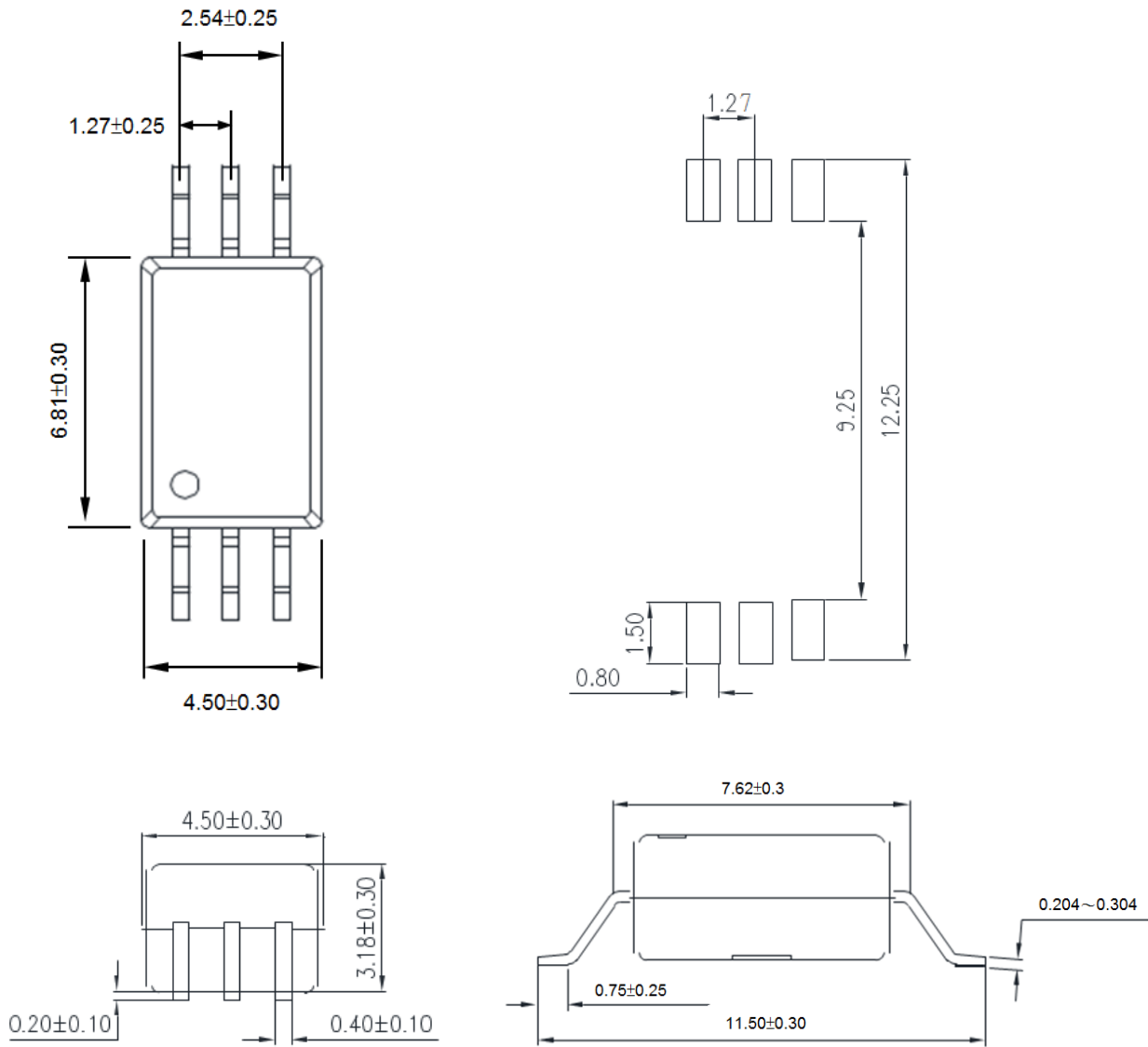

ICPLW50L

TAPE AND REEL PACKAGING

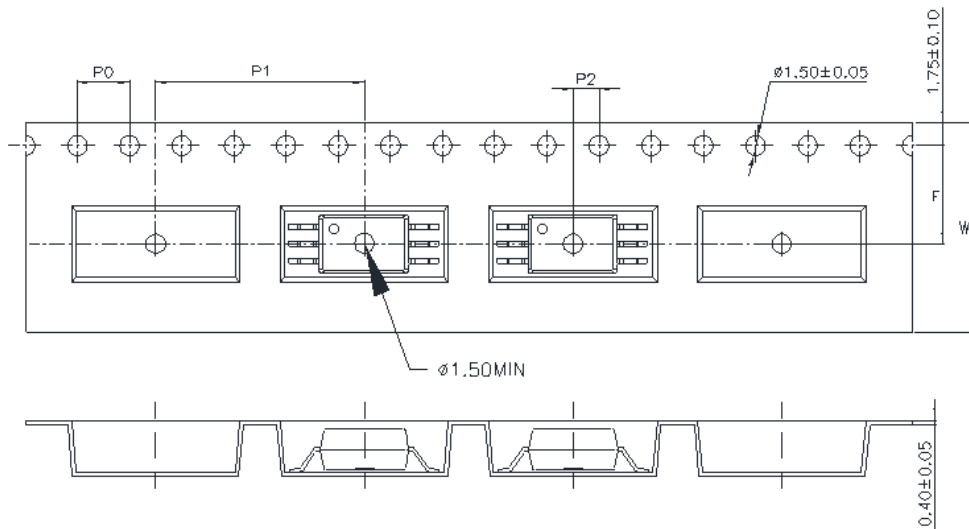

Description	Symbol	Dimension mm (inch)
Tape Width	W	16 ± 0.3 (0.63)
Pitch of Sprocket Holes	P_0	4 ± 0.1 (0.16)
Distance of Compartment to Sprocket Holes	F	7.5 ± 0.1 (0.3)
	P_2	2 ± 0.1 (0.079)
Distance of Compartment to Compartment	P_1	16 ± 0.1 (0.63)

ICPLW50L

IR REFLOW SOLDERING TEMPERATURE PROFILE
One Time Reflow Soldering is Recommended.
Do not immerse device body in solder paste.

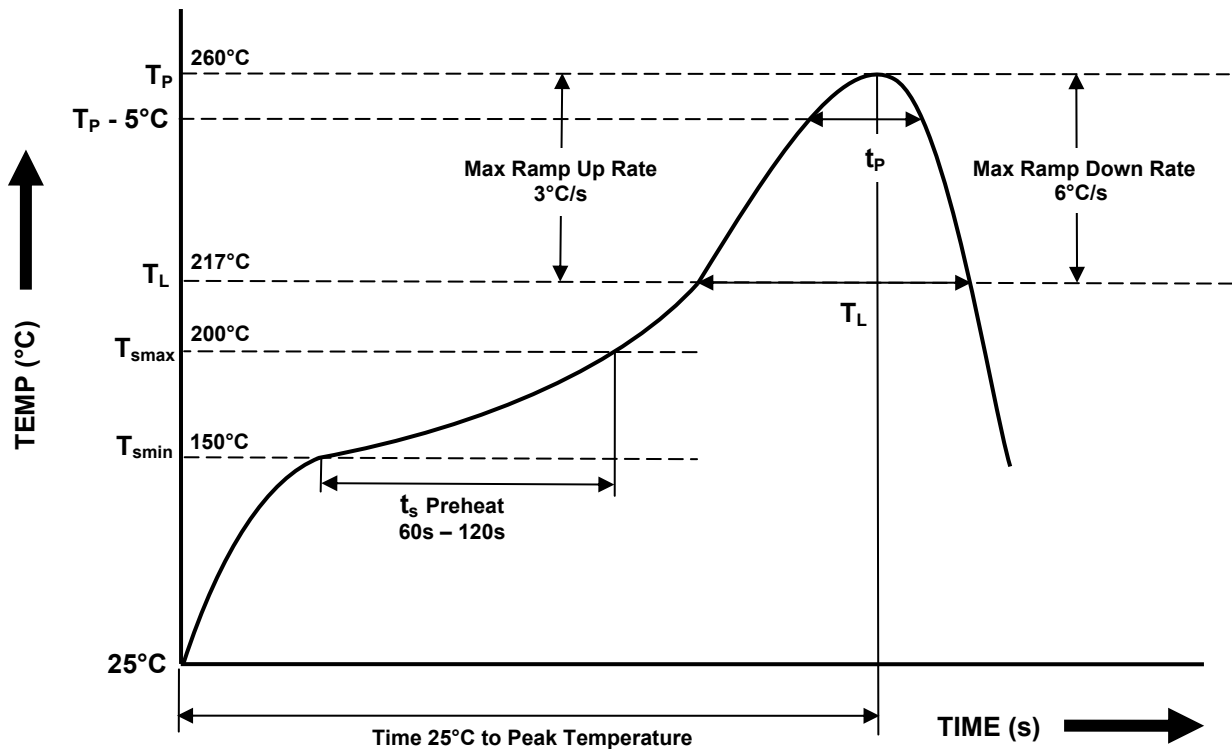

Profile Details	Conditions
Preheat - Min Temperature (T _{SMIN}) - Max Temperature (T _{SMAX}) - Time T _{SMIN} to T _{SMAX} (t _s)	150°C 200°C 60s - 120s
Soldering Zone - Peak Temperature (T _P) - Time at Peak Temperature - Liquidous Temperature (T _L) - Time within 5°C of Actual Peak Temperature (T _P - 5°C) - Time maintained above T _L (t _L) - Ramp Up Rate (T _L to T _P) - Ramp Down Rate (T _P to T _L)	260°C 10s max 217°C 30s max 60s - 100s 3°C/s max 6°C/s max
Average Ramp Up Rate (T _{smax} to T _P)	3°C/s max
Time 25°C to Peak Temperature	8 minutes max



DISCLAIMER

Isocom Components is continually working to improve the quality and reliability of its products. Nevertheless, semiconductor devices in general can malfunction or fail due to their inherent electrical sensitivity and vulnerability to physical stress. It is the responsibility of the buyer, when utilizing Isocom Components products, to comply with the standards of safety in making a safe design for the entire system, and to avoid situations in which a malfunction or failure of such Isocom Components products could cause loss of human life, bodily injury or damage to property.

In developing your designs, please ensure that Isocom Components products are used within specified operating ranges as set forth in the most recent Isocom Components products specifications.

The Isocom Components products listed in this document are intended for usage in general electronics applications (computer, personal equipment, office equipment, measuring equipment, industrial robotics, domestic appliances, etc.). These Isocom Components products are neither intended nor warranted for usage in equipment that requires extraordinarily high quality and/or reliability or a malfunction or failure of which may cause loss of human life or bodily injury ("Unintended Usage"). Unintended Usage include atomic energy control instruments, airplane or spaceship instruments, transportation Instruments, traffic signal instruments, combustion control instruments, medical Instruments, all types of safety devices, etc... Unintended Usage of Isocom Components products listed in this document shall be made at the customer's own risk.

Gallium arsenide (GaAs) is a substance used in the products described in this document. GaAs dust and fumes are toxic. Do not break, cut or pulverize the product, or use chemicals to dissolve them. When disposing of the products, follow the appropriate regulations. Do not dispose of the products with other industrial waste or with domestic garbage.

The products described in this document are subject to the foreign exchange and foreign trade laws.

The information contained herein is presented only as a guide for the applications of our products. No responsibility is assumed by Isocom Components for any infringements of intellectual property or other rights of the third parties which may result from its use. No license is granted by implication or otherwise under any intellectual property or other rights of Isocom Components or others.

The information contained herein is subject to change without notice.