

IS2801- 4, IS2801- 4GB



DESCRIPTION

The IS2801-4 is a four channel optically coupled isolator each channel consists of an infrared emitting diode and optically coupled to an NPN silicon photo transistor.

These devices belong to Isocom Compact Range of Optocouplers.

FEATURES

- Half Pitch 1.27mm
- High AC Isolation voltage 3750V_{RMS}
- Wide Operating Temperature Range -55°C to 110°C
- Pb Free and RoHS Compliant
- UL Approval E91231 Package Code "THP4"

APPLICATIONS

- Hybrid Substrates with High Density Mounting
- Industrial System Controllers
- Measuring Instruments
- System Appliances

ORDER INFORMATION

- Available in Tape and Reel with 2000pcs per reel

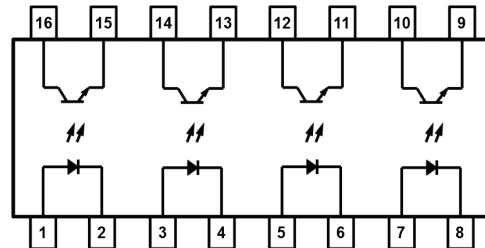

ABSOLUTE MAXIMUM RATINGS (T_A = 25°C)

Stresses exceeding the absolute maximum ratings can cause permanent damage to the device. Exposure to absolute maximum ratings for long periods of time can adversely affect reliability.

Input

Forward Current	50mA
Pulse Forward Current	1A
Reverse Voltage	6V
Power dissipation	70mW

Output

Output Current	50mA
Collector to Emitter Voltage BV _{CEO}	80V
Emitter to Collector Voltage BV _{ECO}	7V
Power Dissipation	100mW

Total Package

Isolation Voltage	3000V _{RMS}
Total Power Dissipation	170mW
Operating Temperature	-55 to 110°C
Storage Temperature	-55 to 150°C
Lead Soldering Temperature (10s)	260°C

ISOCOM COMPONENTS 2004 LTD

Unit 25B, Park View Road West, Park View Industrial Estate
Hartlepool, Cleveland, TS25 1PE, United Kingdom
Tel : +44 (0)1429 863 609 Fax : +44 (0)1429 863 581
e-mail : sales@isocom.co.uk
<http://www.isocom.com>

ISOCOM COMPONENTS ASIA LTD

Hong Kong Office
Block A, 8/F, Wah Hing Industrial Mansions
36 Tai Yau Street, San Po Kong, Kowloon, Hong Kong
Tel : +852 2995 9217 Fax : +852 8161 6292
e-mail : sales@isocom.com.hk



IS2801- 4, IS2801- 4GB

ELECTRICAL CHARACTERISTICS ($T_A = 25^\circ\text{C}$ unless otherwise specified)

INPUT

Parameter	Symbol	Test Condition	Min	Typ.	Max	Unit
Forward Voltage	V_F	$I_F = 20\text{mA}$		1.2	1.4	V
Reverse Current	I_R	$V_R = 4\text{V}$			10	μA
Terminal Capacitance	C_t	$V_F = 0\text{V}, f = 1\text{KHz}$		30	250	pF

OUTPUT

Parameter	Symbol	Test Condition	Min	Typ.	Max	Unit
Collector-Emitter Breakdown Voltage	BV_{CEO}	$I_F = 0, I_C = 0.1\text{mA}$	80			V
Emitter-Collector Breakdown Voltage	BV_{ECO}	$I_F = 0, I_E = 10\mu\text{A}$	7			V
Collector-Emitter Dark Current	I_{CEO}	$I_F = 0, V_{CE} = 48\text{V}$			100	nA

COUPLED

Parameter	Symbol	Test Condition	Min	Typ.	Max	Unit
Current Transfer Ratio	CTR	$I_F = 5\text{mA}, V_{CE} = 5\text{V}$ IS2801-4 IS2801-4GB	50 100		600 600	%
Collector-Emitter Saturation Voltage	$V_{CE(sat)}$	$I_F = 8\text{mA}, I_C = 2.4\text{mA}$			0.4	V
Floating Capacitance	C_f	$V_{CE} = 0\text{V}, f = 1\text{MHz}$		0.6	1	pF
Output Rise Time	t_r	$V_{CE} = 10\text{V}$ $I_C = 2\text{mA}$ $R_L = 100\Omega$		2	18	μs
Output Fall Time	t_f			3	18	
Turn-On Time	t_{ON}			3		
Turn-Off Time	t_{OFF}			3		
Turn-On Time	t_{ON}	$V_{CC} = 5\text{V}$ $I_C = 16\text{mA}$ $R_L = 1.9\text{k}\Omega$		2		
Turn-Off Time	t_{OFF}			40		
Storage Time	t_s			25		

ISOLATION

Parameter	Symbol	Test Condition	Min	Typ.	Max	Unit
Input to Output Isolation Voltage	V_{ISO}	$RH = 40\% - 60\%, t = 1 \text{ min}$ Note 1	3000			V_{RMS}
Input to Output Isolation Resistance	R_{ISO}	$RH = 40\% - 60\%, V_{IO} = 500\text{V}$ Note 1	5×10^{10}	1×10^{11}		Ω

IS2801- 4, IS2801- 4GB

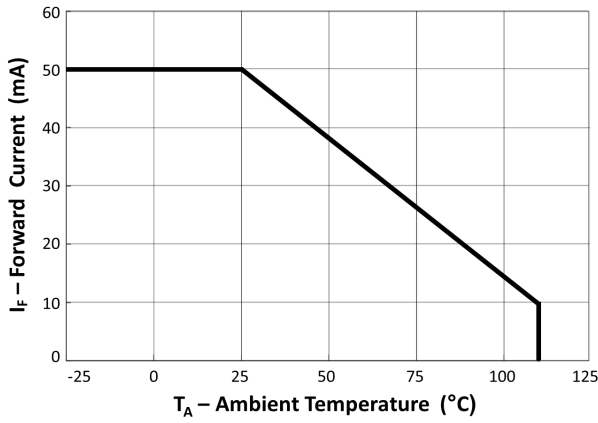

Fig 1 Forward Current vs T_A

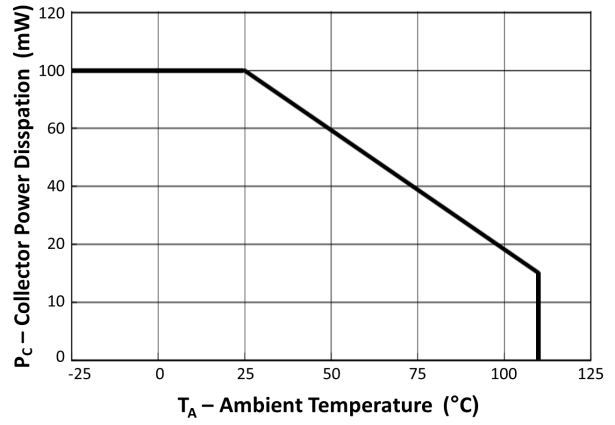

Fig 2 Collector Power Dissipation vs T_A

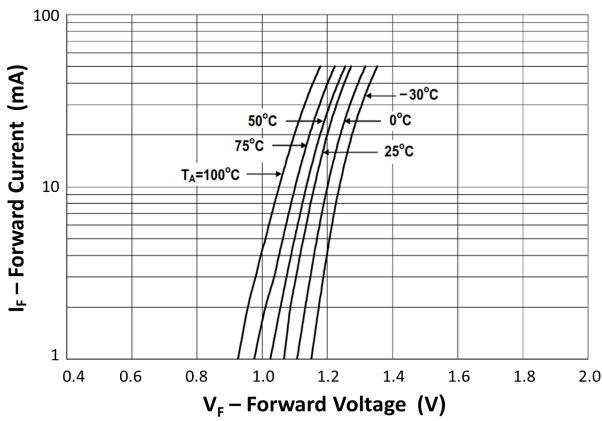

Fig 3 Forward Current vs Forward Voltage

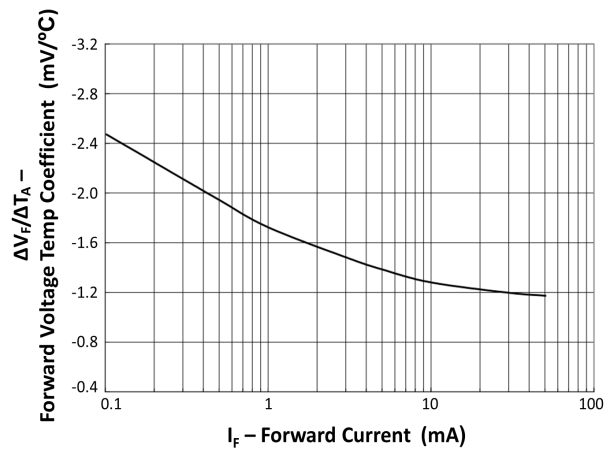

Fig 4 Forward Current Temperature Coefficient vs Forward Current

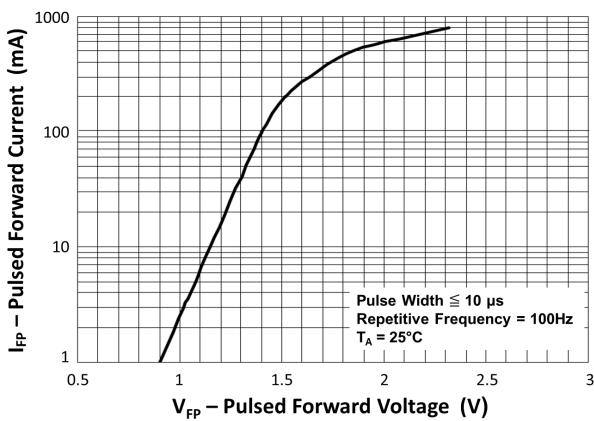

Fig 5 Pulse Forward Current vs Pulse Forward Voltage

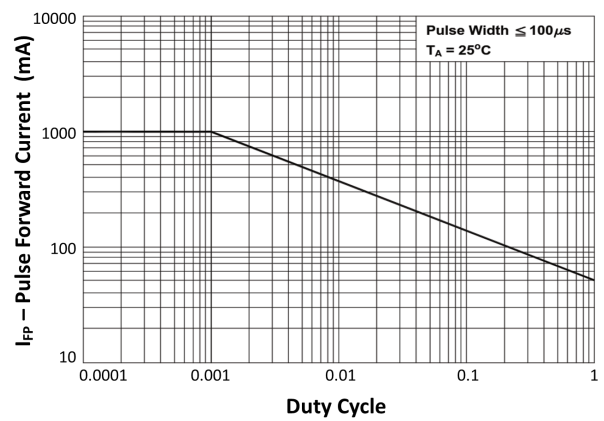

Fig 6 Pulse Forward Current vs Duty Cycle

IS2801- 4, IS2801- 4GB

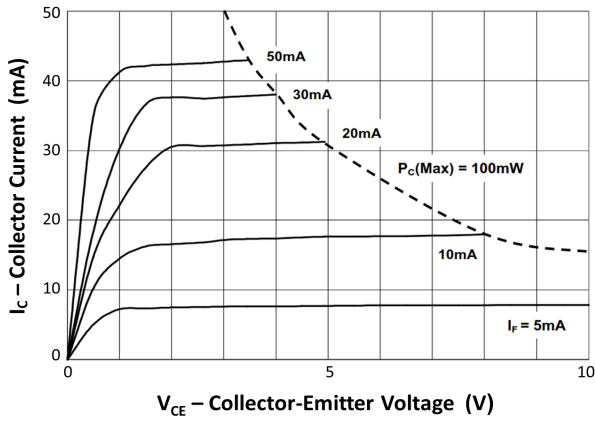

Fig 7 Collector Current vs Collector-Emitter Voltage

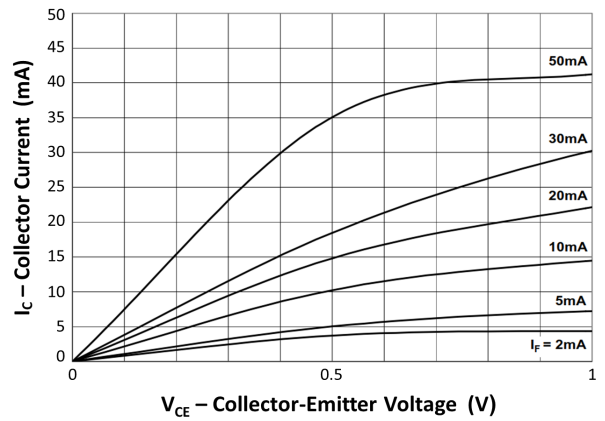

Fig 8 Collector Current vs

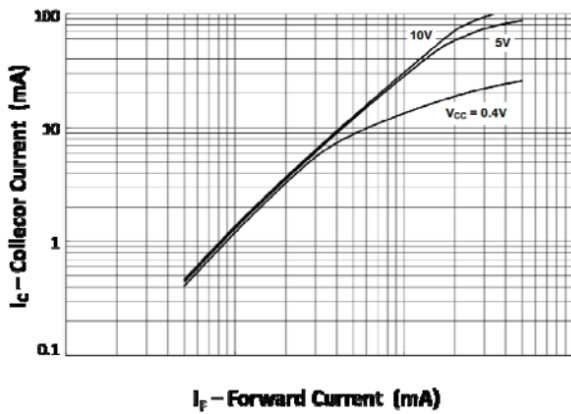

Fig 9 Collector Current vs Forward Current

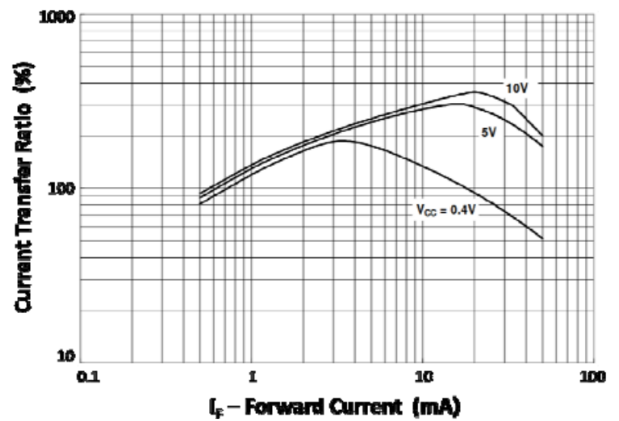

Fig 10 Current Transfer Ratio vs Forward Current

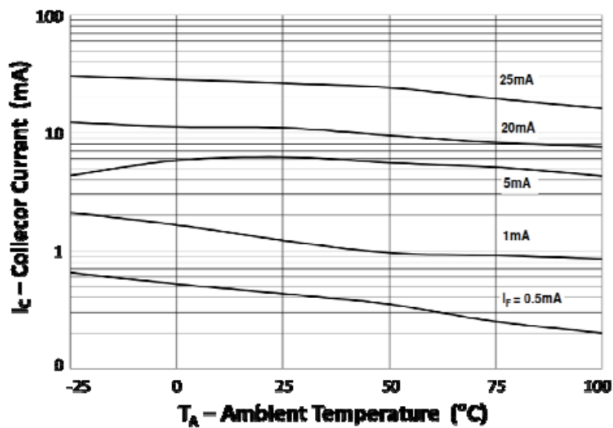

Fig 11 Collector Current vs T_A

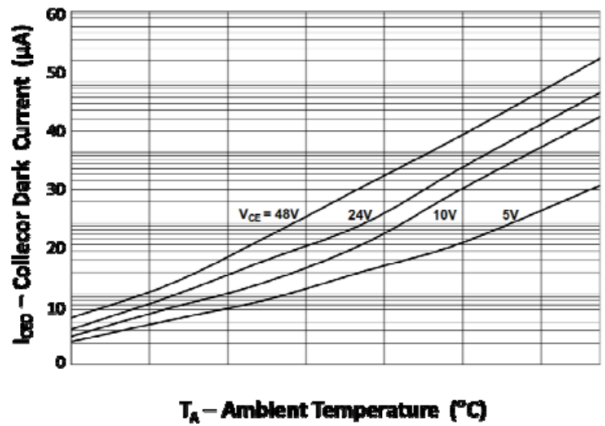

Fig 12 Collector Dark Current vs T_A

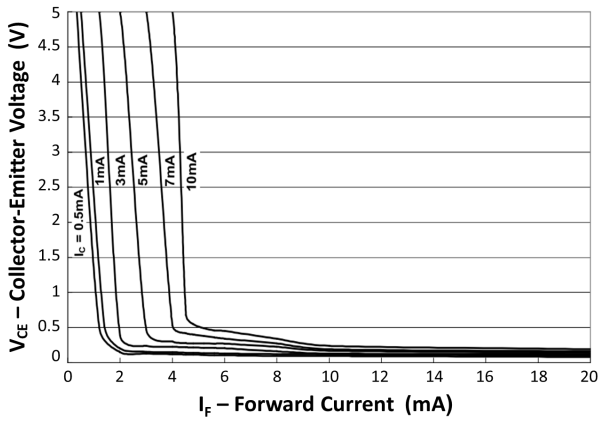

Fig 13 Collector-Emitter Voltage vs Forward Current

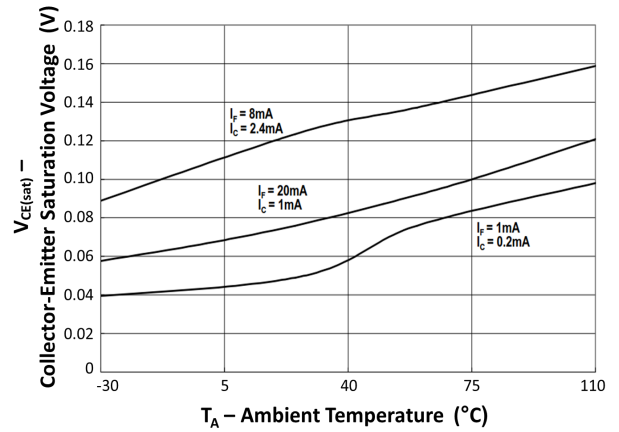

Fig 14 Collector-Emitter Saturation Voltage vs T_A

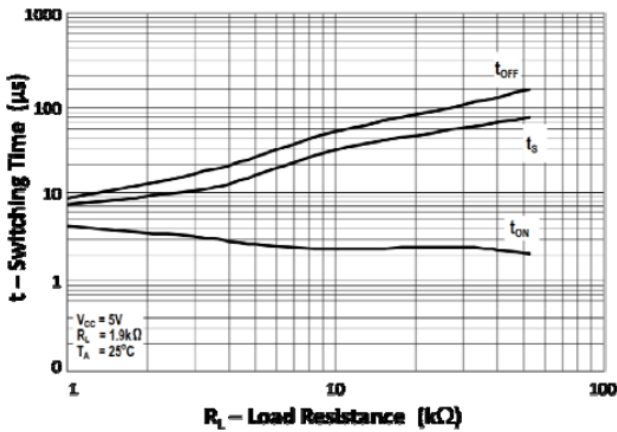

Fig 15 Switching Time vs Load Resistance

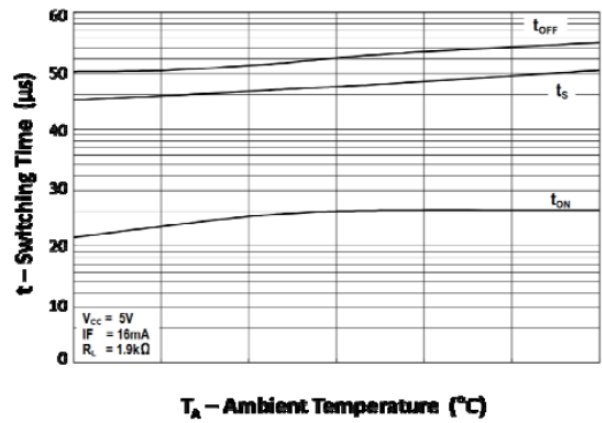

Fig 16 Switching Time vs T_A

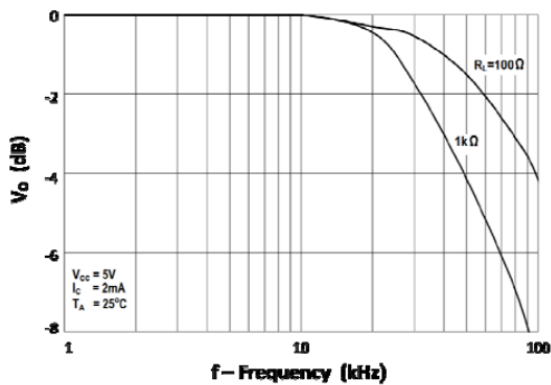
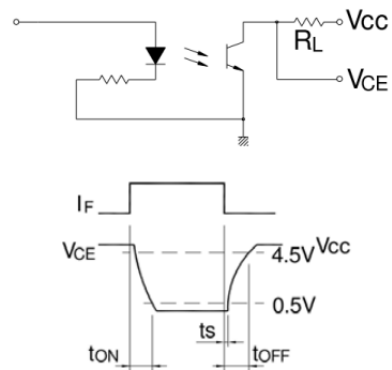

Fig 17 Frequency Response



Switching Time Test Circuit

IS2801- 4, IS2801- 4GB

ORDER INFORMATION

UL Approval			
After PN	PN	Description	Packing quantity
None	IS2801-4, IS2801-4GB	Surface Mount Tape & Reel	2000 pcs per reel

DEVICE MARKING

IS2801-4GB
IS2801-4

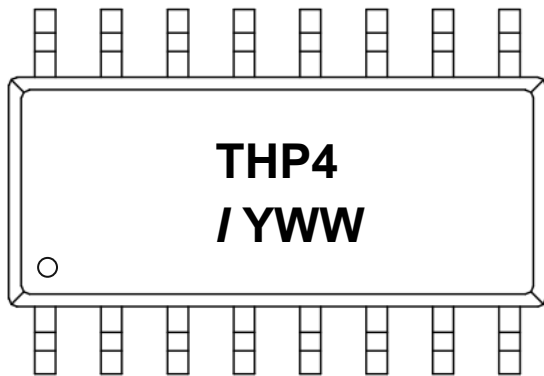

THP4 denotes Device Part Number
 / denotes Isocom
 Y denotes 1 digit Year code
 WW denotes 2 digit Week code

IS2801- 4, IS2801- 4GB

PACKAGE DIMENSIONS (mm)

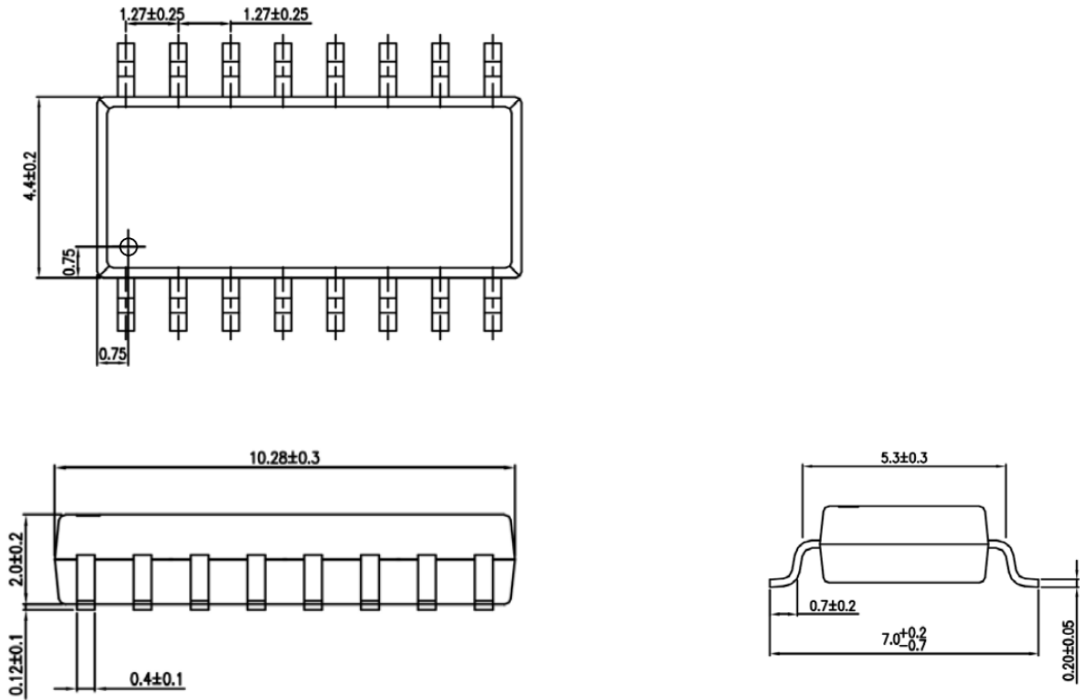

RECOMMENDED SOLDER PAD LAYOUT (mm)

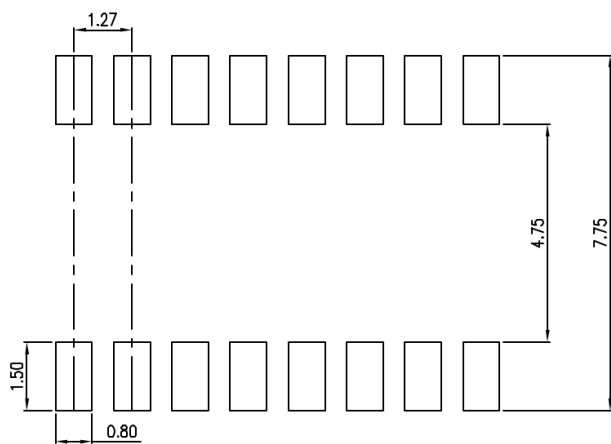



IS2801- 4, IS2801- 4GB

TAPE AND REEL PACKAGING

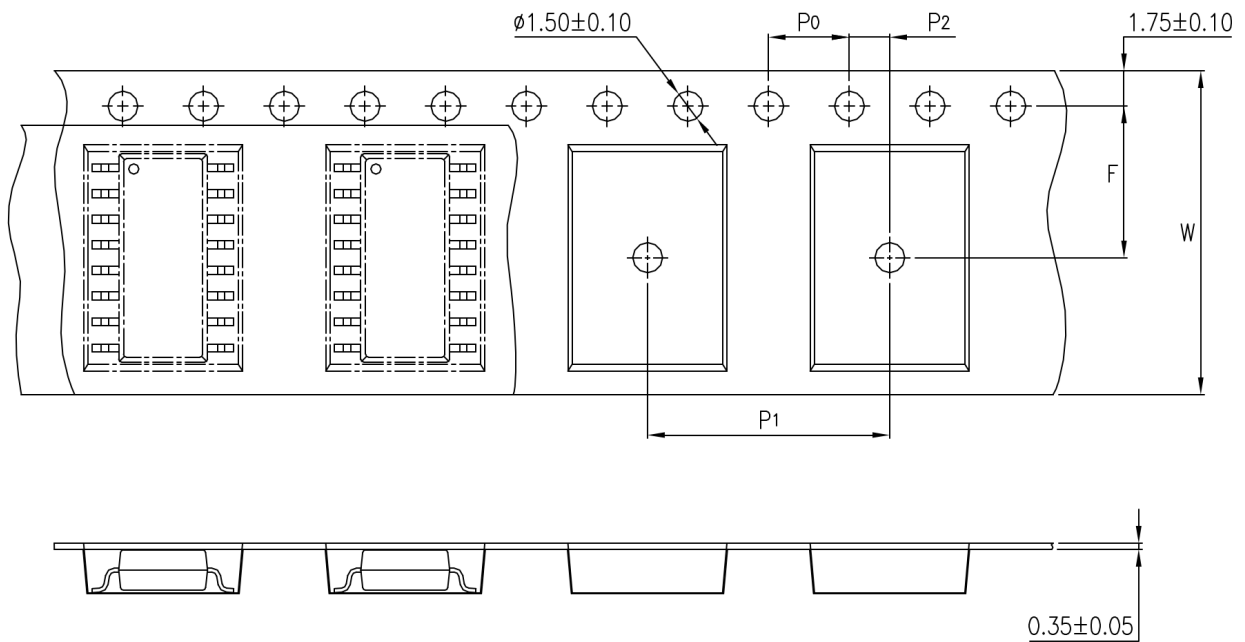

Description	Symbol	Dimension mm (inch)
Tape Width	W	16 ± 0.3 (0.63)
Pitch of Sprocket Holes	P_0	4 ± 0.1 (0.15)
Distance of Compartment to Sprocket Holes	F	7.5 ± 0.1 (0.295)
	P_2	2 ± 0.1 (0.079)
Distance of Compartment to Compartment	P_1	12 ± 0.1 (0.47)



IS2801- 4, IS2801- 4GB

IR REFLOW SOLDERING TEMPERATURE PROFILE
One Time Reflow Soldering is Recommended.

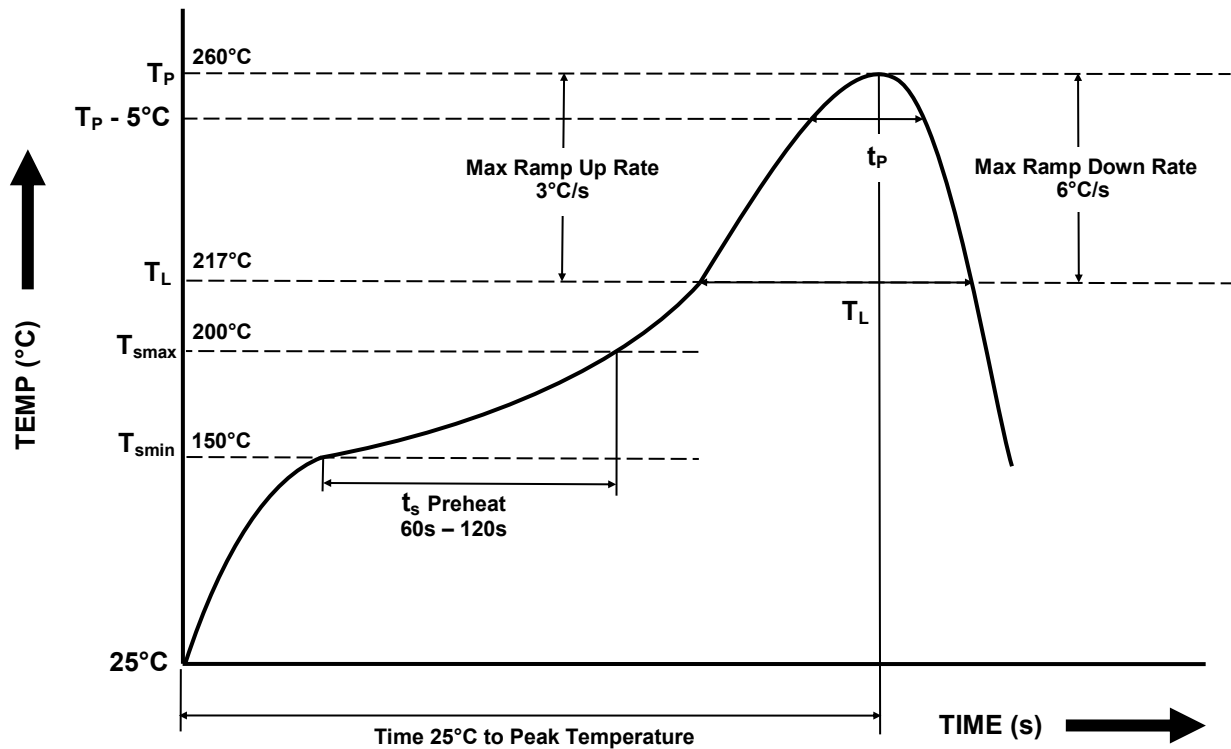

Profile Details	Conditions
Preheat - Min Temperature (T_{SMIN}) - Max Temperature (T_{SMAX}) - Time T_{SMIN} to T_{SMAX} (t_s)	150°C 200°C 60s - 120s
Soldering Zone - Peak Temperature (T_P) - Time at Peak Temperature - Liquidous Temperature (T_L) - Time within 5°C of Actual Peak Temperature ($T_P - 5^\circ C$) - Time maintained above T_L (t_L) - Ramp Up Rate (T_L to T_P) - Ramp Down Rate (T_P to T_L)	260°C 10s max 217°C 30s max 60s - 100s 3°C/s max 6°C/s max
Average Ramp Up Rate (T_{smax} to T_P)	3°C/s max
Time 25°C to Peak Temperature	8 minutes max

Notes:

- Isocom is continually improving the quality, reliability, function or design and Isocom reserves the right to make changes without further notices.
- The products shown in this publication are designed for the general use in electronic applications such as office automation equipment, communications devices, audio/visual equipment, electrical application and instrumentation.
- For equipment/application where high reliability or safety is required, such as space applications, nuclear power control equipment, medical equipment, etc., please contact our sales representatives.
- When requiring a device for any "specific" application, please contact our sales for advice.
- The contents described herein are subject to change without prior notice.
- Do not immerse unit's body in solder paste.



DISCLAIMER

Isocom Components is continually working to improve the quality and reliability of its products. Nevertheless, semiconductor devices in general can malfunction or fail due to their inherent electrical sensitivity and vulnerability to physical stress. It is the responsibility of the buyer, when utilizing Isocom Components products, to comply with the standards of safety in making a safe design for the entire system, and to avoid situations in which a malfunction or failure of such Isocom Components products could cause loss of human life, bodily injury or damage to property.

In developing your designs, please ensure that Isocom Components products are used within specified operating ranges as set forth in the most recent Isocom Components products specifications.

The Isocom Components products listed in this document are intended for usage in general electronics applications (computer, personal equipment, office equipment, measuring equipment, industrial robotics, domestic appliances, etc.). These Isocom Components products are neither intended nor warranted for usage in equipment that requires extraordinarily high quality and/or reliability or a malfunction or failure of which may cause loss of human life or bodily injury ("Unintended Usage"). Unintended Usage include atomic energy control instruments, airplane or spaceship instruments, transportation Instruments, traffic signal instruments, combustion control instruments, medical Instruments, all types of safety devices, etc... Unintended Usage of Isocom Components products listed in this document shall be made at the customer's own risk.

Gallium arsenide (GaAs) is a substance used in the products described in this document. GaAs dust and fumes are toxic. Do not break, cut or pulverize the product, or use chemicals to dissolve them. When disposing of the products, follow the appropriate regulations. Do not dispose of the products with other industrial waste or with domestic garbage.

The products described in this document are subject to the foreign exchange and foreign trade laws.

The information contained herein is presented only as a guide for the applications of our products. No responsibility is assumed by Isocom Components for any infringements of intellectual property or other rights of the third parties which may result from its use. No license is granted by implication or otherwise under any intellectual property or other rights of Isocom Components or others.

The information contained herein is subject to change without notice.